

Alubin de México

CATALOGO FACHADA NACIONAL

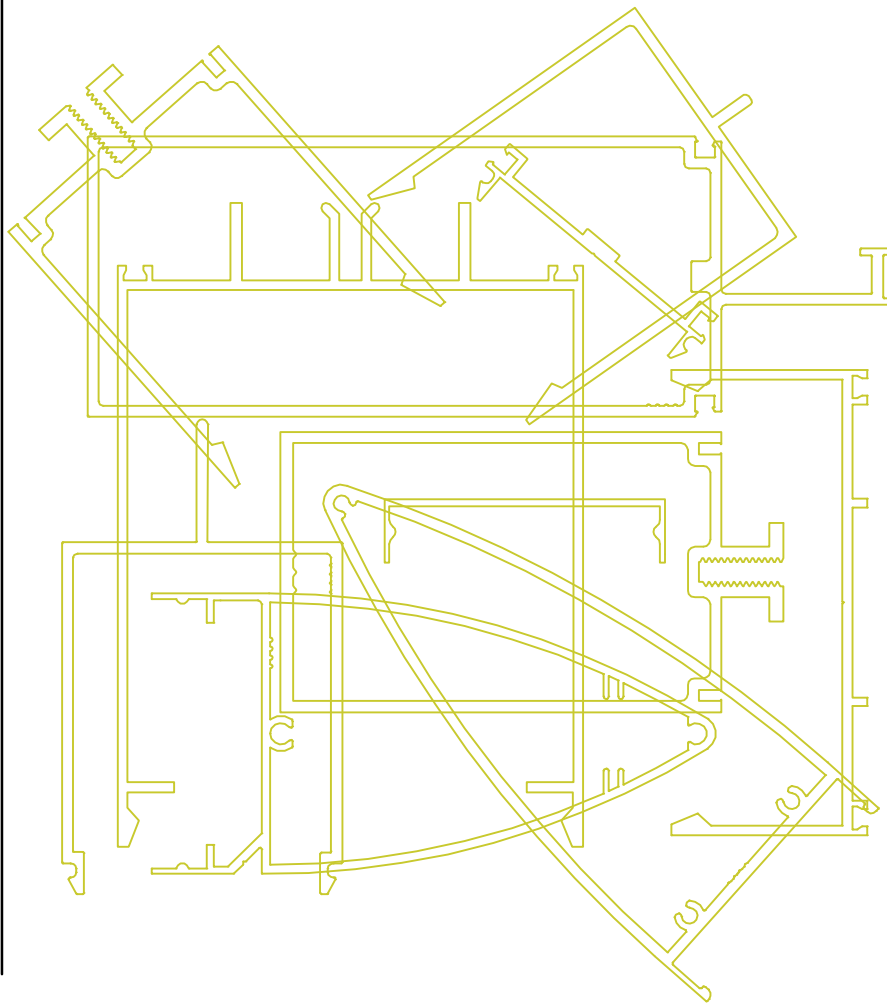











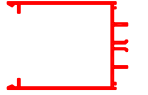





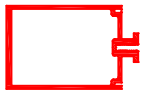











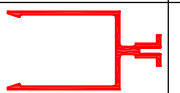
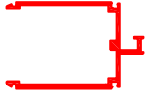

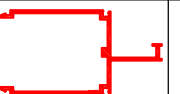



Alubin de México

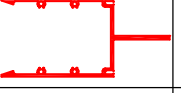

PLANTA: CALLE 2 SUR No. 120, PARQUE INDUSTRIAL TOLUCA 2000. C.P. 50200 TOLUCA, EDO DE MÉXICO, MÉXICO. TEL.: (01 722) 2621500 FAX (01 722) 2621509

Alubin de México

INDICE FACHADA NACIONAL

Dibujo	Clave	Pag.	Dibujo	Clave	Pag.	Dibujo	Clave	Pag.
	10000	01		10146	13		10848	09
	10002	01		10147	13		10900	09
	10003	02		10148	05		10901	09
	10004	02		10149	05		11417	10
	10005	02		10150	05		14349	10
	10006	02		10195	06		14350	10
	10012	03		10196	06		14351	10
	10035	03		10289	07		14698	11
	10036	03		10409	07		14739	11
	10073	14		10436	08		61428	12
	10127	04		10437	08		65389	12
	10134	04		10443	14			
	10135	14		10583	08			

Alubin de México

FACHADA NACIONAL

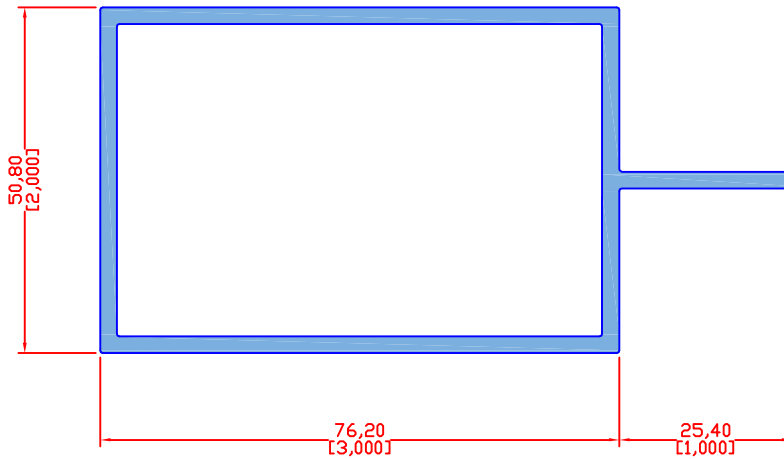

Clave 10000
Básico
Peso: 1.820 Kg/m
Perímetro: 30.34 cm

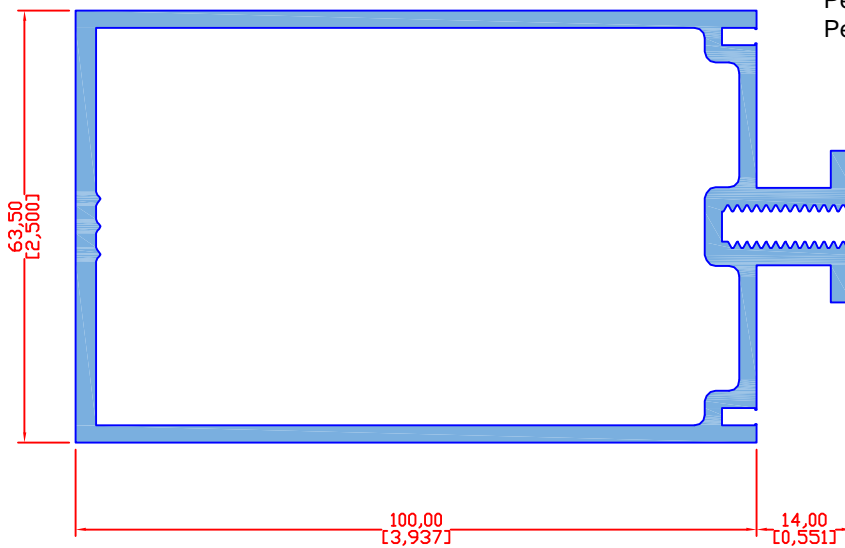

Clave 10002
Básico Vertical
Peso: 2.744 Kg/m
Perímetro: 46.15 cm

Alubin de México

FACHADA NACIONAL

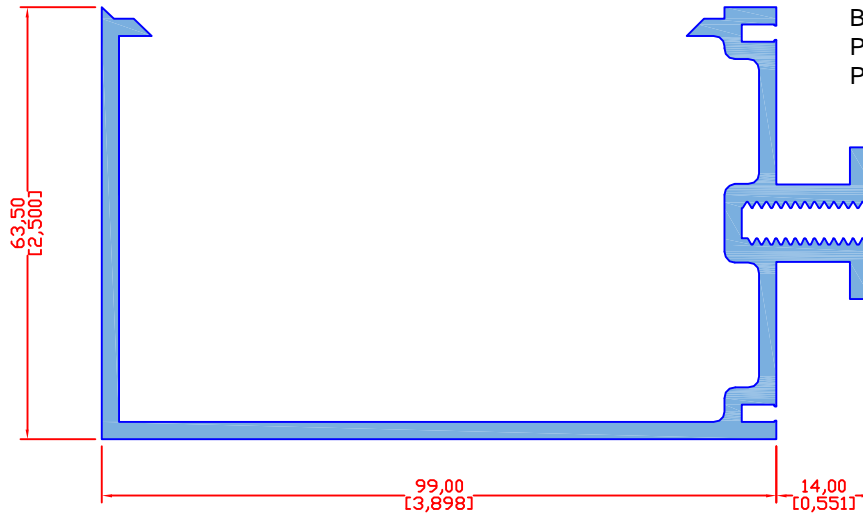

Clave 10003
Básico Horizontal
Peso: 2.086 Kg/m
Perímetro: 61.15 cm

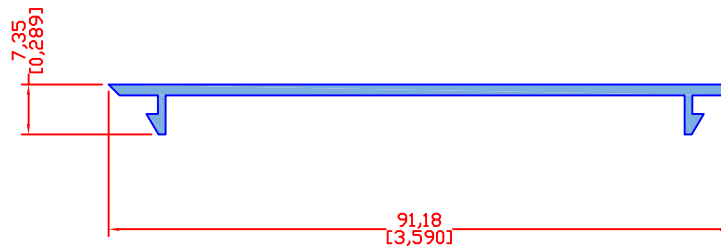

Clave 10004
Tapa para Básico Horizontal
Peso: 0.441 Kg/m
Perímetro: 21.16 cm

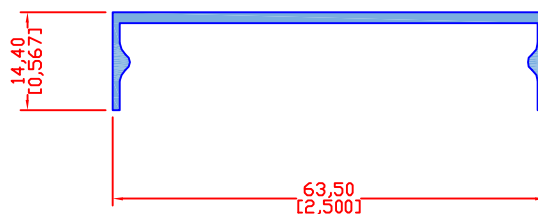

Clave 10005
Tapa Exterior para Mullion
Peso: 0.372 Kg/m
Perímetro: 18.32 cm

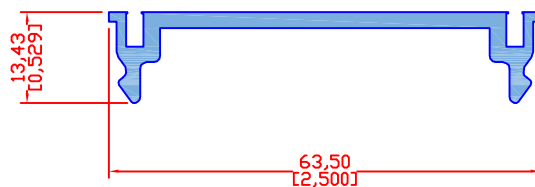

Clave 10006
Mullion Portavidrio
Peso: 0.583 Kg/m
Perímetro: 19.84 cm

Alubin de México

FACHADA NACIONAL

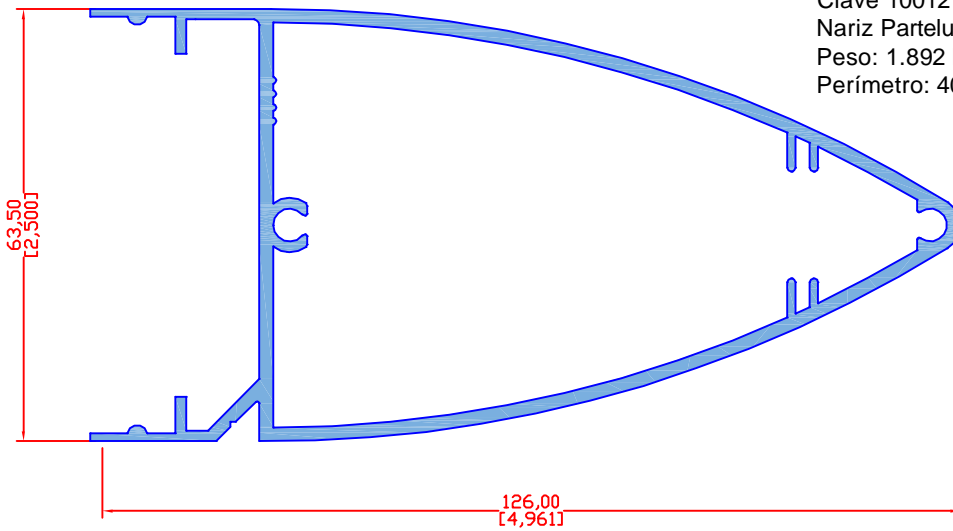

Clave 10012
Nariz Parteluz
Peso: 1.892 Kg/m
Perímetro: 40.96 cm

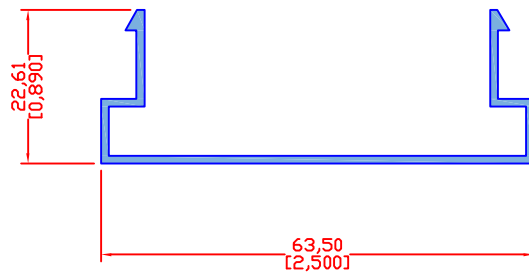

Clave 10035
Tapa Exterior para Básico
Peso: 0.375 Kg/m
Perímetro: 23.99 cm

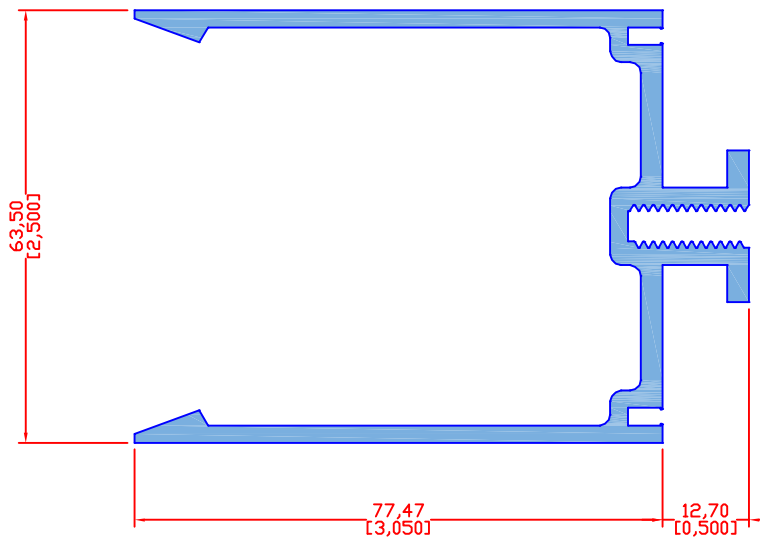

Clave 10036
Básico Horizontal
Peso: 2.026 Kg/m
Perímetro: 56.12 cm

Alubin de México

FACHADA NACIONAL

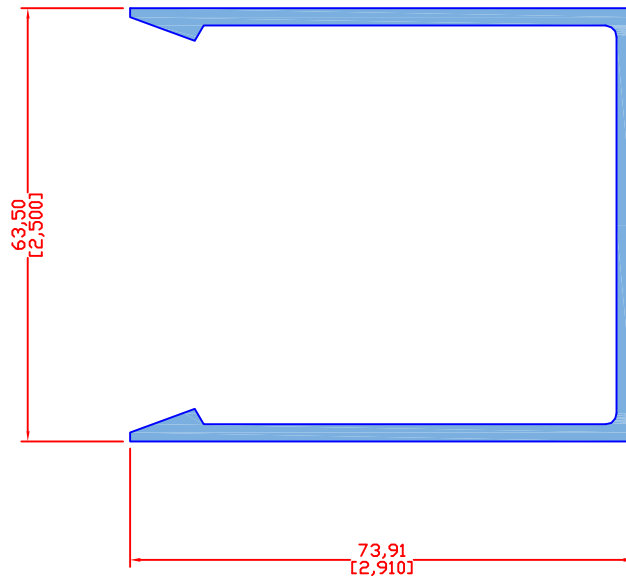

Clave 10127
Básico
Peso: 1.457 Kg/m
Perímetro: 41.60 cm

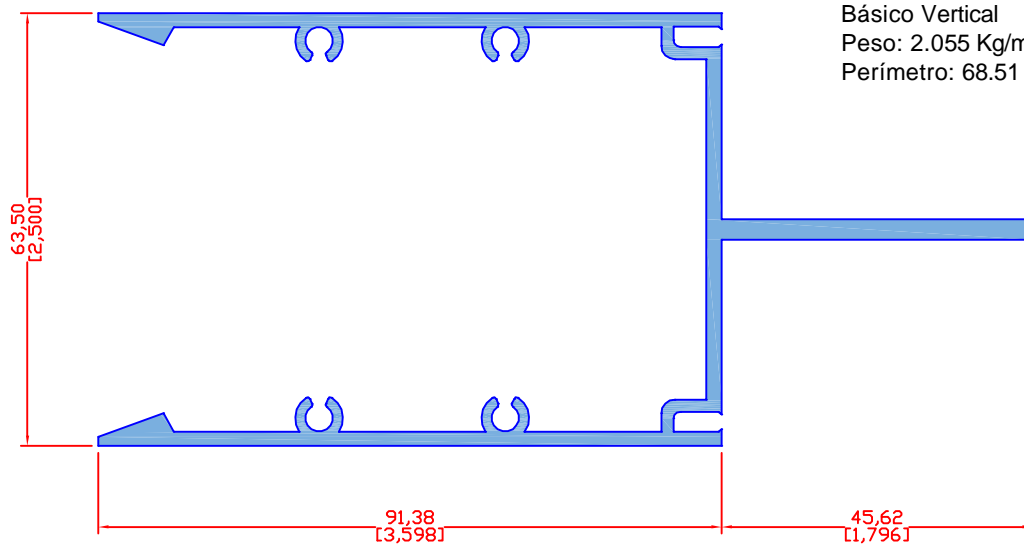

Clave 10134
Básico Vertical
Peso: 2.055 Kg/m
Perímetro: 68.51 cm

Alubin de México

FACHADA NACIONAL

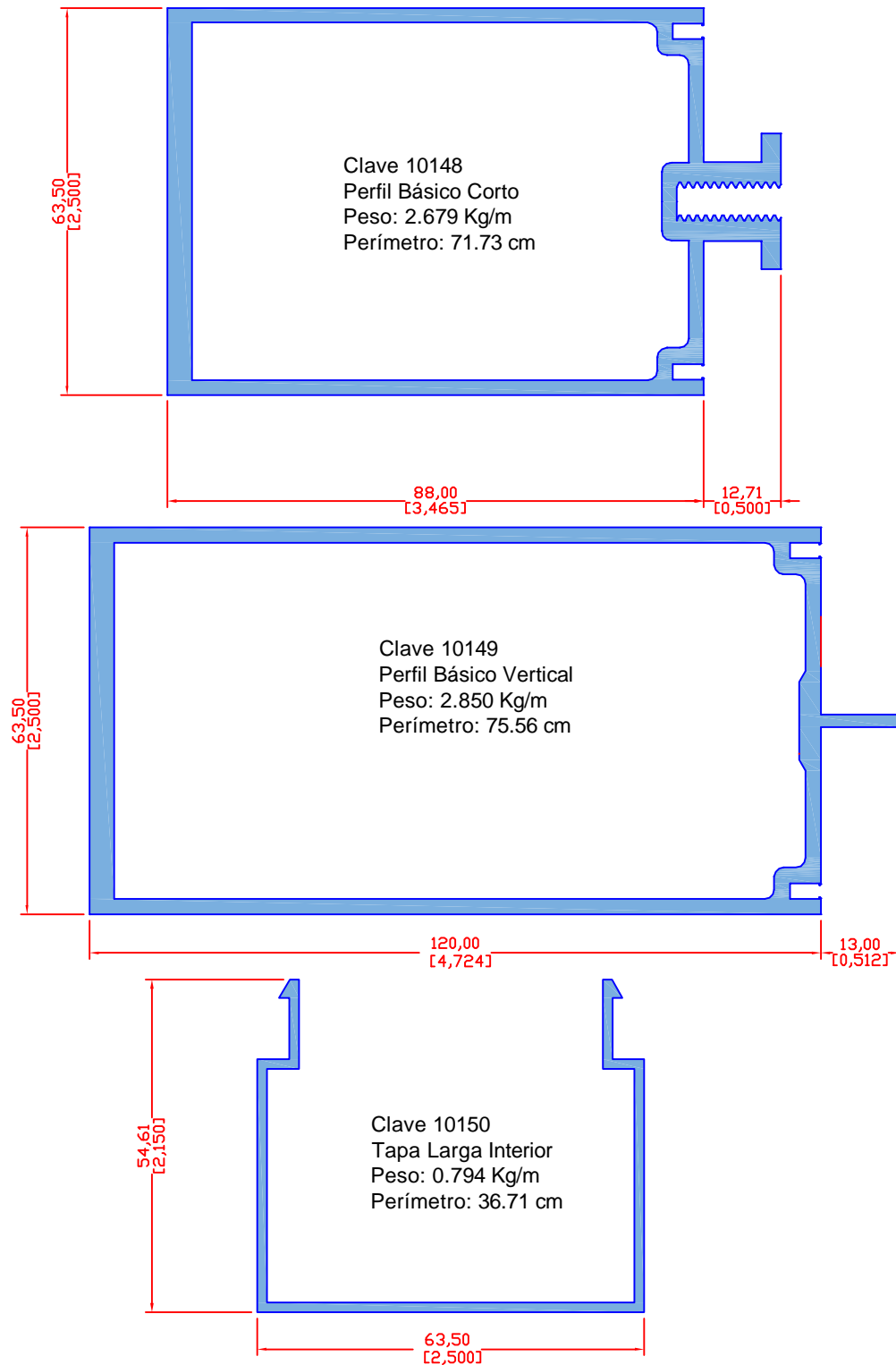

Alubin de México

FACHADA NACIONAL

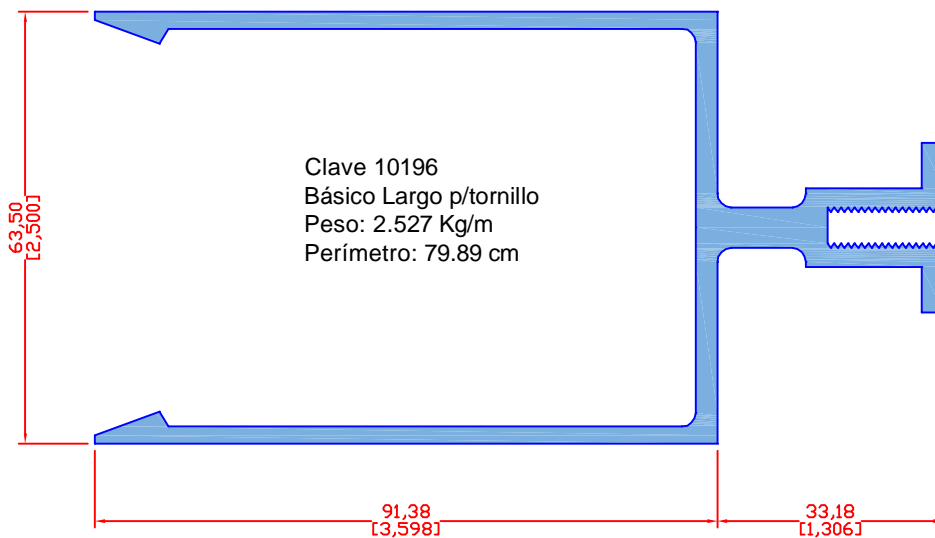
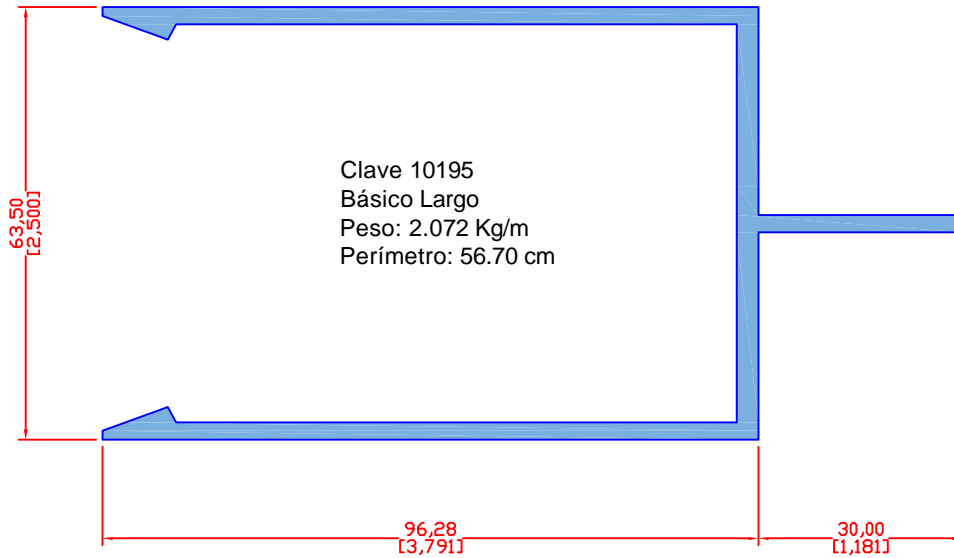

Alubin de México

FACHADA NACIONAL

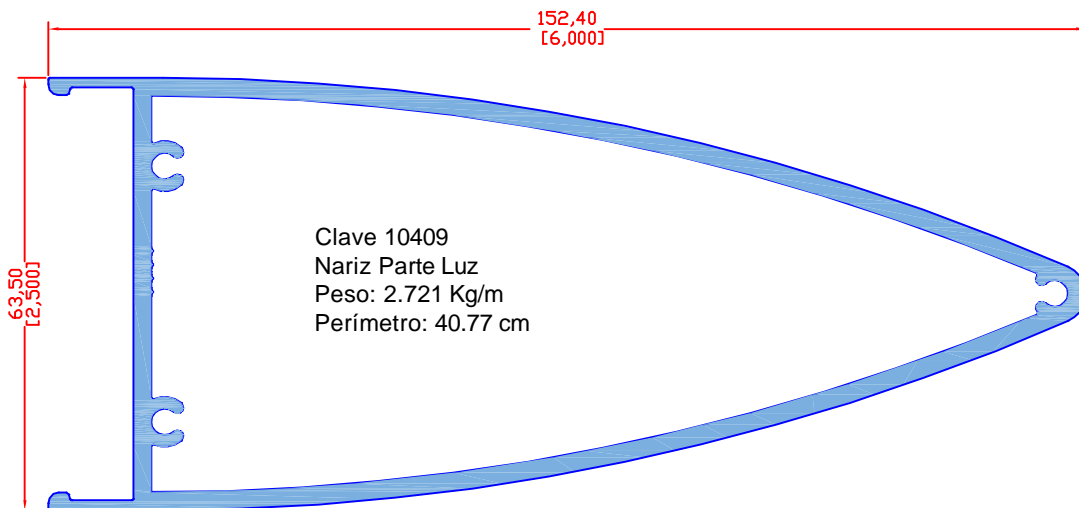
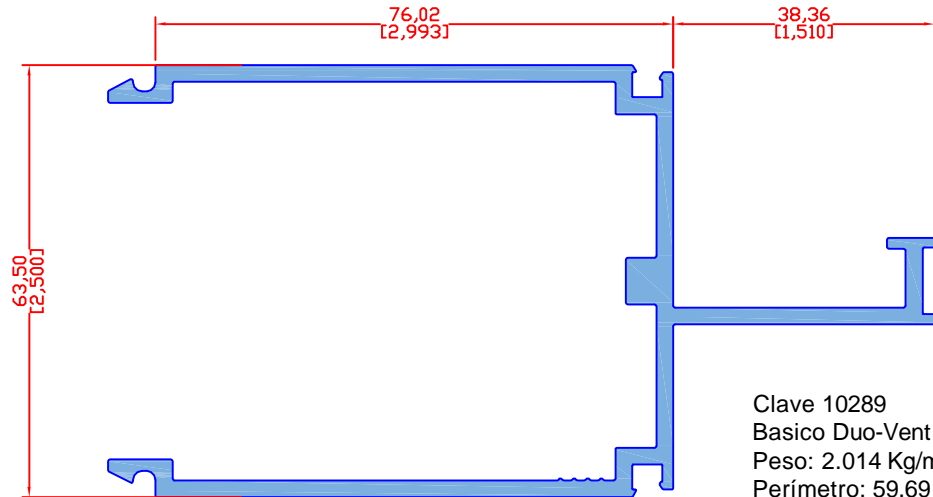

Alubin de México

FACHADA NACIONAL

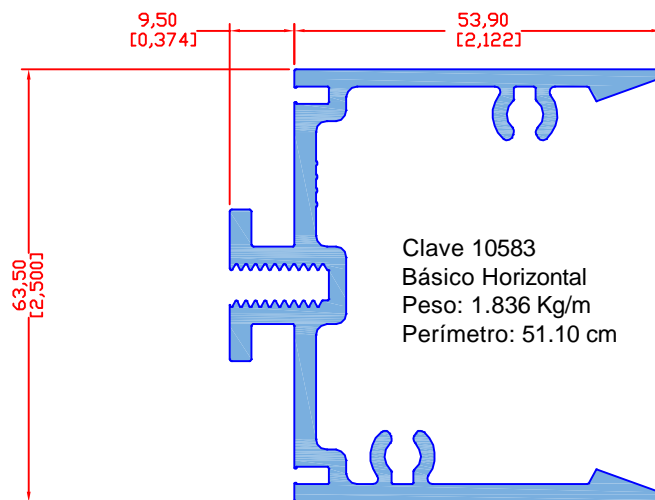
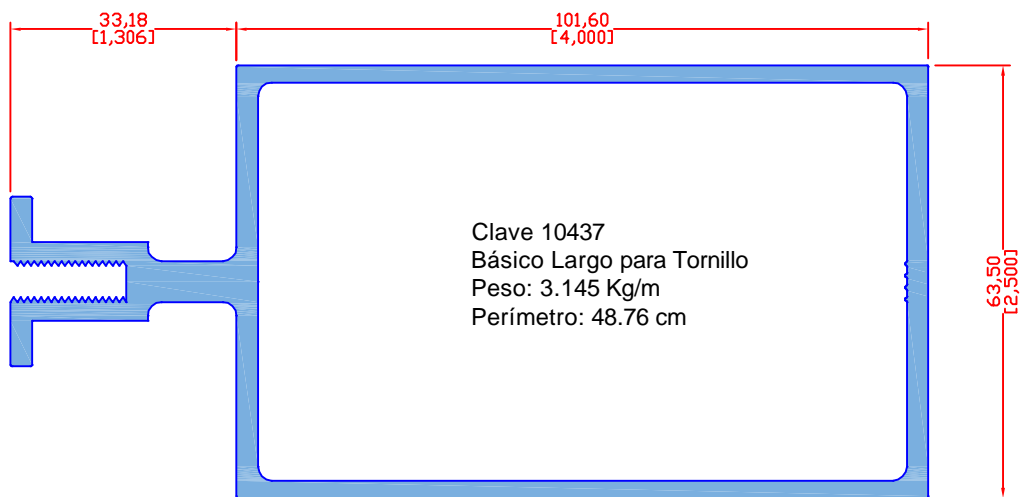
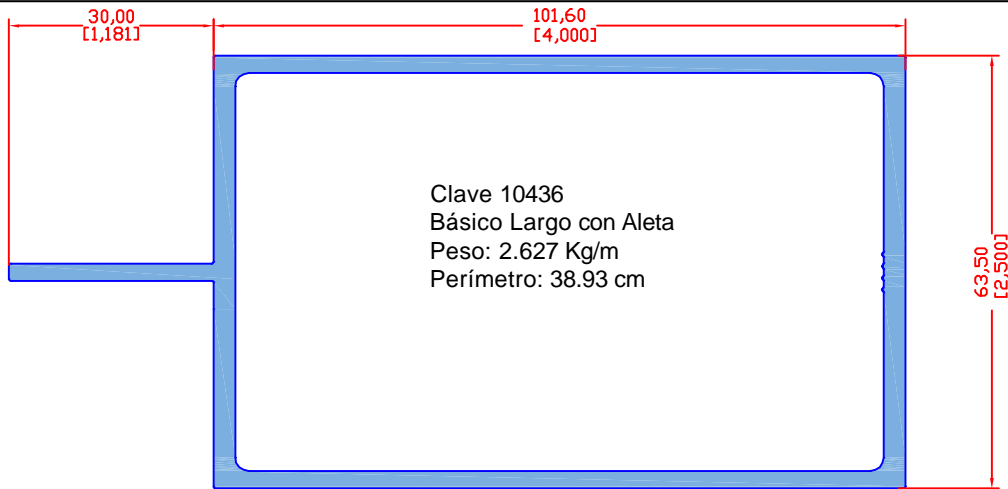

Alubin de México

FACHADA NACIONAL

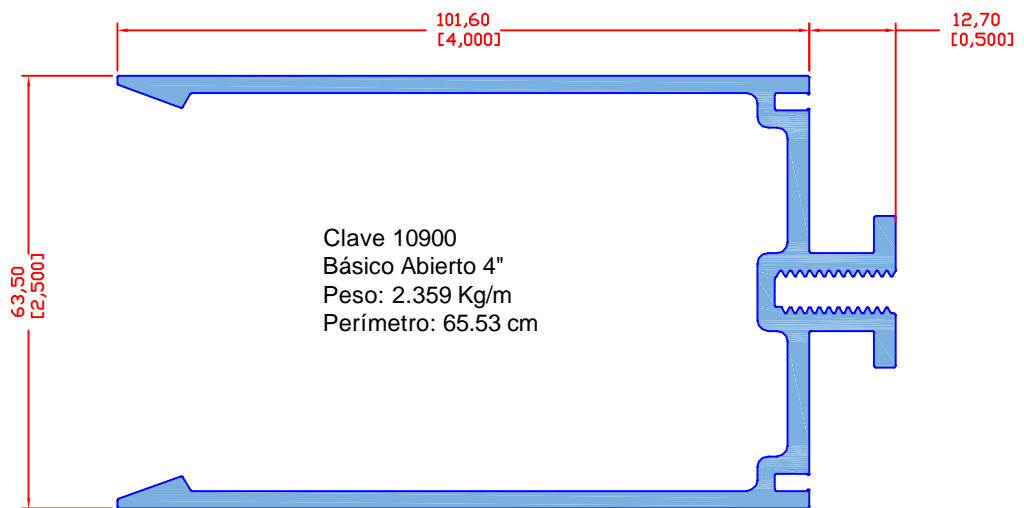
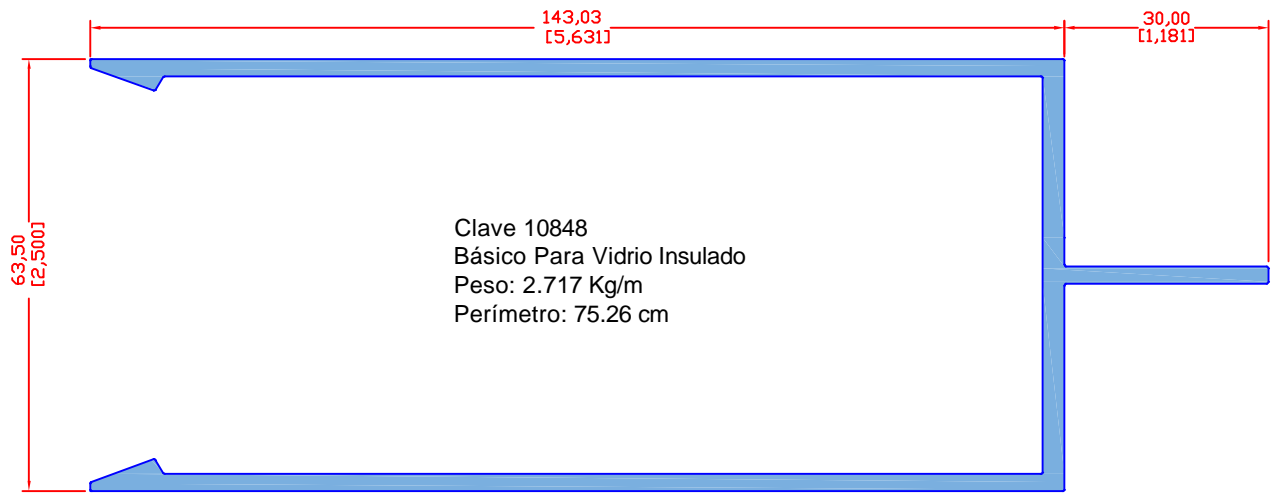

Alubin de México

FACHADA NACIONAL

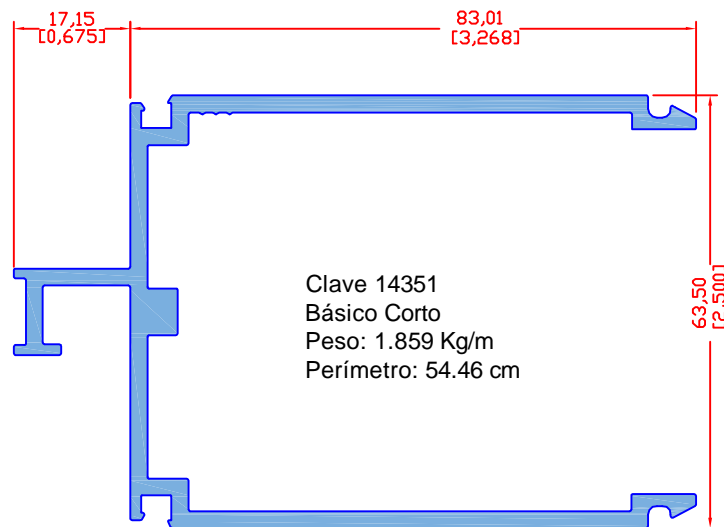
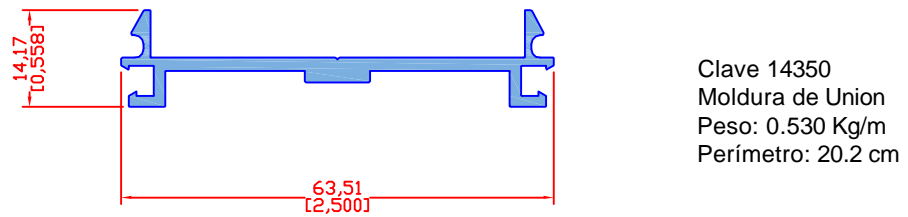
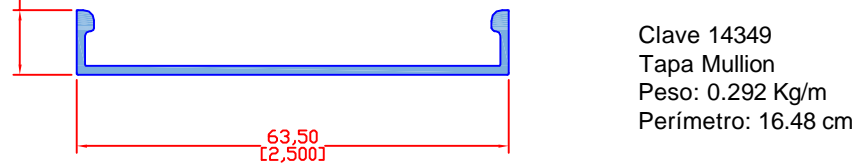
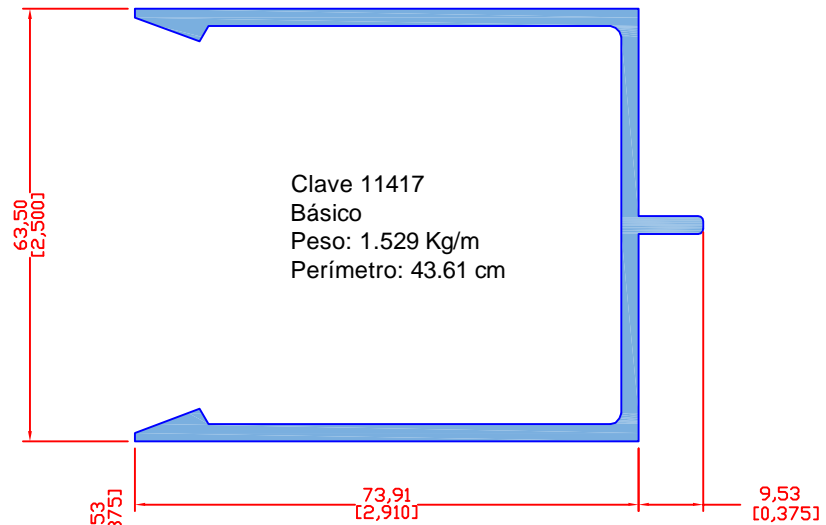

Alubin de México

FACHADA NACIONAL

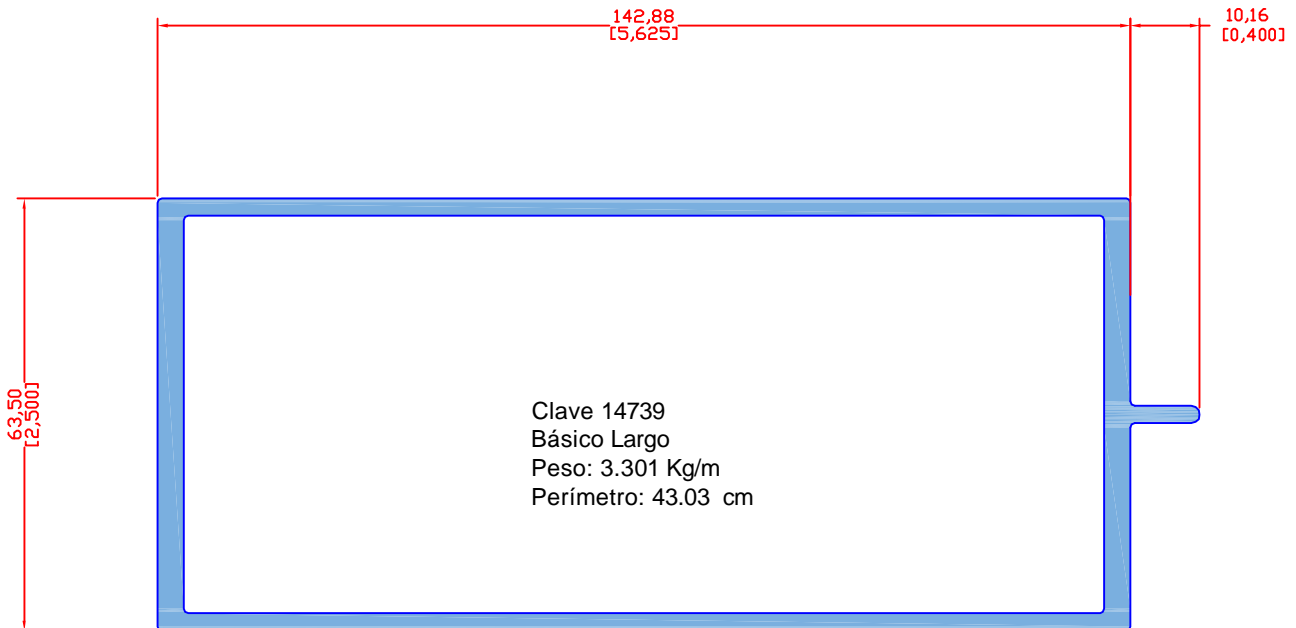
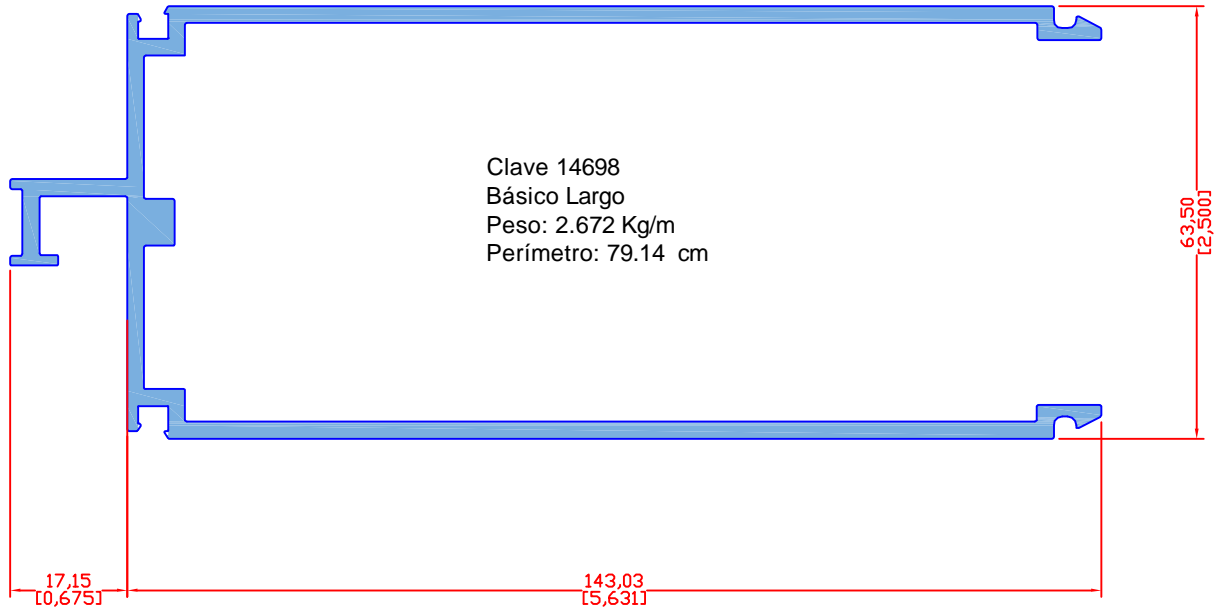

Alubin de México

FACHADA NACIONAL

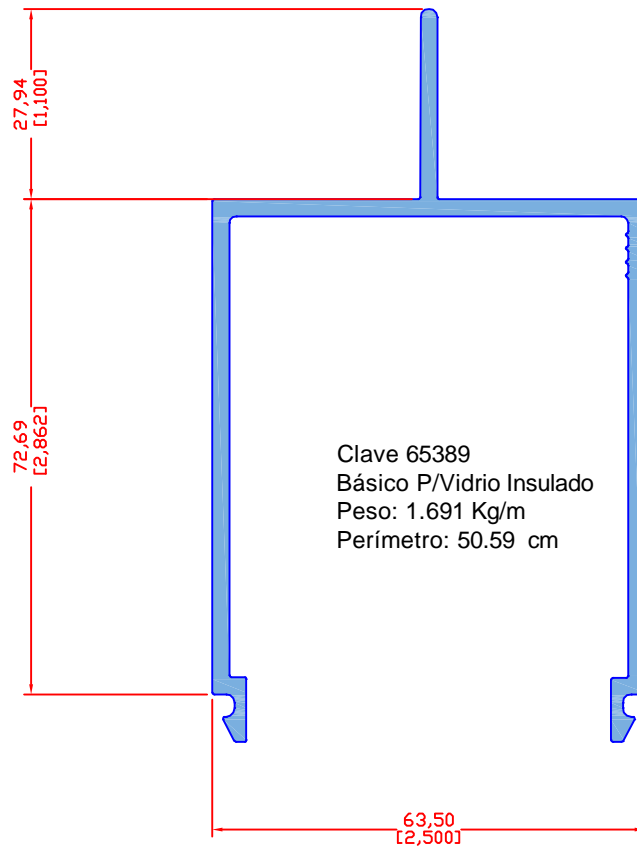
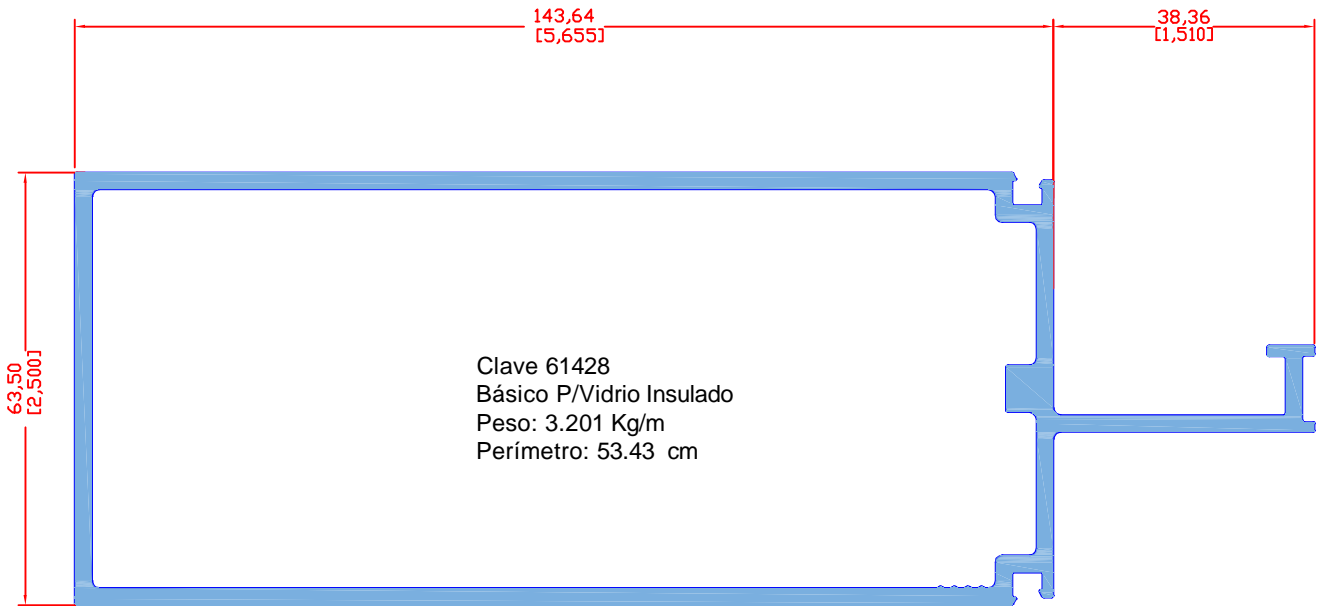

Alubin de México

FACHADA NACIONAL

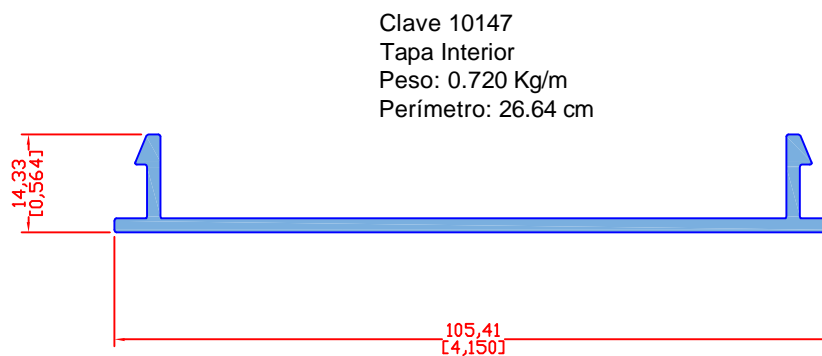
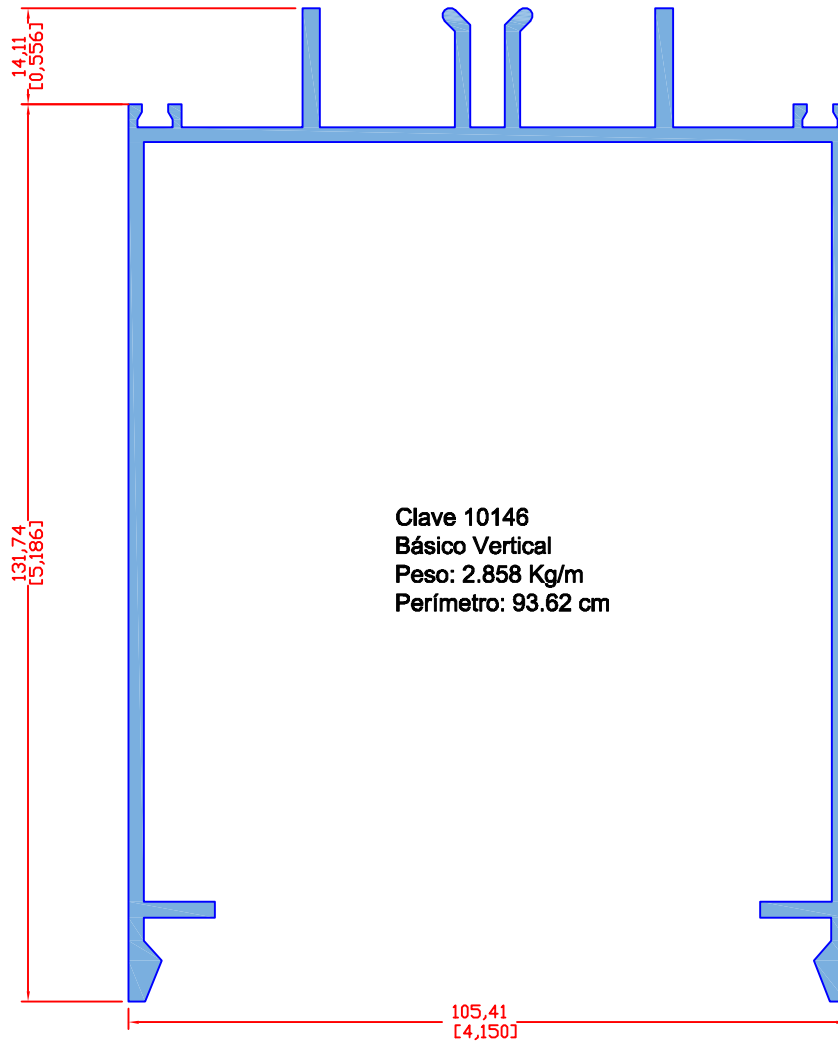

Alubin de México

FACHADA NACIONAL

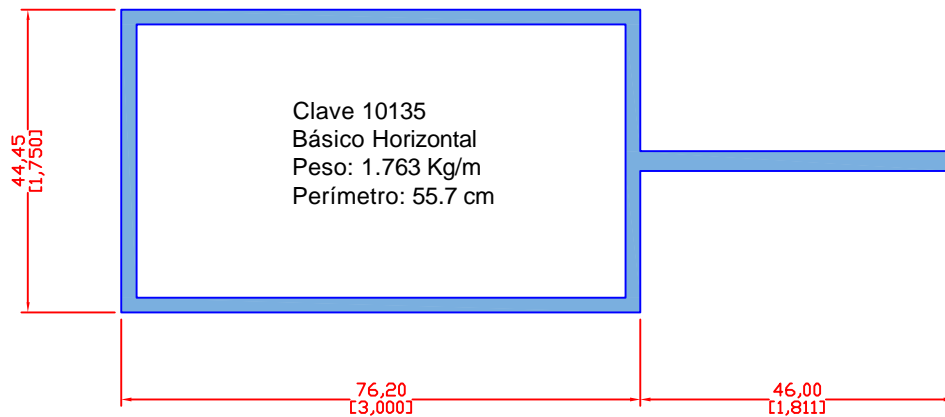
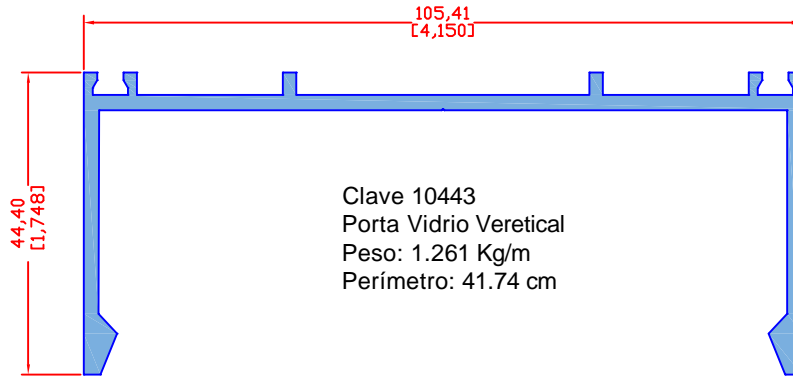

Alubin de México

FACHADA NACIONAL



Dirección: Calle 2 sur No.120
Parque Industrial Toluca 2000, Toluca
C. P. 50200 Edo. de Mex.
Tel: (01 722) 262 15 00
Fax: (01 722) 262 15 09
01 800 288 02 00
Direccion E. : www.alubin.com.mx
E. Mail: ventas@alubin.com.mx

Reviso: Ing. Juventino H. Hernández Ángeles

Alubin de México



PLANTA: CALLE 2 SUR No. 120, PARQUE INDUSTRIAL TOLUCA 2000. C.P. 50200 TOLUCA, EDO DE MÉXICO, MÉXICO. TEL.: (01 722) 2621500 FAX (01 722) 2621509

www.alubin.com.mx Revisión 2017